

TUNG-SOL / CHATHAM

MEDIUM MU TWIN POWER TRIODE FOR SERIES REGULATOR SERVICE

DESCRIPTION — The 6528 is a long life, mechanically rugged, twin power triode developed especially for use as a passing tube in series regulated power supplies. For this service, a tube must be able to pass large currents over a wide voltage range and still exhibit a low intrinsic voltage drop when operated "wide open." The 6528 not only meets these requirements but possesses the additional advantage of requiring little grid voltage swing to control these currents. This permits the use of simpler control amplifier circuits in the regulated supply.

The design features zirconium coated graphite anodes that, while lighter in weight than similar metal anodes, remain warp free during life and provide one of the best gas "gettering" means known. The anodes are supported by ceramic insulators. The use of these insulators and the hard glass envelope permit the tube to be outgassed at high temperatures during the manufacturing exhaust process. This allows the tube to be run at high temperatures during operation, without the evolution of harmful gas from the tube parts.

Massive cathodes provide adequate emission current reserve. Gold plated molybdenum wires are employed in the rugged grid structure. The tube mount is built on a rugged button stem, and is supported from the bulb by means of flexible metal vibration snubbers.

In Regulator circuits one 6528 will replace two or three type 6080 WA or three or four beam power tubes. For even higher levels of current or power, many 6528 tube sections can be paralleled as explained in the application notes.

TYPE 6528

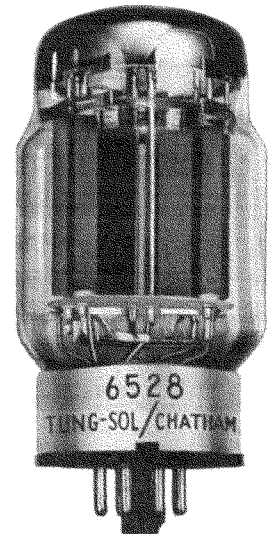

ELECTRICAL DATA

Heater Voltage	6.3 ± 10% volts	Inter Electrode Capacities per Triode Section	
Heater Current (E _r = 6.3 volts)	5.0 amperes	Grid to Cathode	17.8 uuf
Minimum Cathode Heating Time	30 seconds	Grid to Plate	23.8 uuf
Transconductance (per section)	37,000 umhos	Cathode to Plate	2.9 uuf
Amplification Factor	9.0	Heater to Cathode	15.0 uuf
Plate Resistance	245 ohms	Inter Electrode Capacities Between Triode Sections	
		Section 1 Plate to Section 2 Plate	0.6 uuf

MECHANICAL DATA

Mounting Position	Any	Average Net Weight	3.5 ounces
(If tube is to be mounted in a horizontal position it is recommended that it be mounted so that the base lug key be either directly up or directly down)		Maximum Shock Rating (Navy Hi Impact Shock Machine)	720 G
Bulb	TT 16 Nonex	Maximum Vibration Rating	
Base	Large wafer octal with metal sleeve, 8 pin, JETC # B8-86	(10 to 50 cps)	10 G
		(50 to 500 cps)	5 G

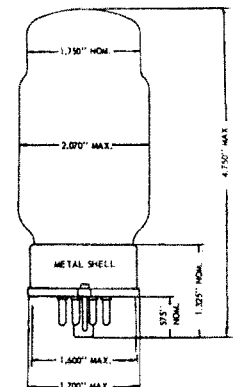

RATINGS, ABSOLUTE VALUES

Power Dissipation per Plate	Min. —	Max. 30	watts
Plate Current per Plate	—	300	milliamperes d. c.
If tube voltage drop is to be swung more than 6 volts, this current cannot be realized. See Plate Characteristics Curve.			
Plate Voltage	0	400	volts d. c.
Heater-Cathode Voltage	-300	+300	volts d. c.
Grid Voltage	-300	0	volts d. c.
Grid Current per Grid	—	0	milliamperes
Heater Voltage	5.7	6.9	volts
Envelope Temperature	—	250	°C.
Altitude for Full Ratings	—	10,000	feet
If cooling is provided to keep bulb temperature within ratings, altitude rating can be extended to 60,000 feet.			
Circuit Values			
Total Grid Circuit Resistance in Regulator Service or with fixed bias	500	50,000	ohms
Total Grid Circuit Resistance with cathode bias only	500	500,000	ohms
Resistance per grid leg when triode sections are paralleled	500	—	ohms
Cathode Resistance: Minimum cathode resistance per cathode leg shall be 10 ohms or that resistance necessary to provide 10% of the grid bias voltage, whichever is greater.			

GLASS BULB

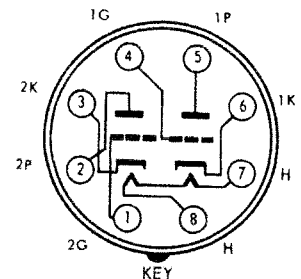

**Bottom View
Large Wafer Octal
with Metal Sleeve**

Additional Tests to Insure Reliability

Randomly Selected Samples are Subjected to the Following Tests

Shock: 48° Hammer Angle in Navy, Flyweight,
High Impact Machine (720 /Gmsec)

Life Test: 1000 hours under plate current test conditions ($R_{c/k} = .05$ Meg.)

Post Shock and Life Test End Points:

Plate Current.....	130 mA min.
Transconductance per section.....	23,500 μ mho min.
HK Leakage.....	100 μ A max.
Grid Current per Section.....	-4 μ A max.

Range of Values

Conditions: $E_f = 6.3$ V, $E_r = 100$ V

$E_c = -4$, $R_{p/g} = 500 \Omega$

Both sections operating. Readings taken after
2 min. preheating under conditions of $E_f = 6.3$,
 $E_{h,h} = 190$ V, $E_r = 0$, $R_k = 200$ ohms. Each
section read separately.

Plate Current per Section.....	140	230	Milliamperes, d.c.
Amplification Factor.....	7.0	11.0	
Transconductance.....	29,000	45,000	Micromhos
Heater Current per tube.....	4.75	5.25	Amperes
Conditions: $E_f = 6.3$ V, $E_r = 400$ V			
$E_c = -75$ V, $R_k = 0$			
Plate Current per section.....	0	3	Milliamperes

Application Notes

The 6528 is admirably suitable for use as a "passing" tube or series regulator in electronically controlled power supplies because of its ability to pass large currents and to easily control them. To provide the desired output current, many triode sections can be paralleled. If tube sections are to be paralleled, however, the designer is strongly urged to use sufficient resistance in each cathode leg to equalize current division among the triode sections. Recommended values for various operating currents are shown on the plate characteristics curve. If the output current of the supply is not fixed, use the resistance indicated for the lowest current that approaches the maximum plate dissipation line. Cathode resistance is superior to anode resistance because it provides more bias on the sections taking greater plate current. A cathode resistor need be only one tenth the value ($\frac{R}{n+1}$) of a plate resistor, and therefore will dissipate only one tenth the power. In any case, the only losses incurred in using a resistor is the insertion loss of the resistor itself (less than one watt) and the additional voltage (less than 6 volts) necessary from the unregulated supply. A cathode resistor adds a small additional loss by causing the passing tube to work with higher bias and hence with greater tube drop.

A thirty second cathode warmup time is recommended before the plate voltage is applied. This is especially necessary in circuits where the amplifier tube plate resistor is returned to the plate side of the passing tube, as illustrated in the simplified circuit in Figure 1. In this case during warmup the amplifier tube draws little current, there is little IR drop across the resistor, and the grid of the passing tube is effectively, tied to the plate. The plate will attempt to draw excessive current from the passing tube's cathode which may seriously impair tube life. The circuit in Figure 2 is preferable from the consideration of the safety of the passing tube both during warmup and in the event of trouble in the amplifier circuit or if the amplifier tube is removed from its socket. It has the additional advantage of providing a constant voltage for the amplifier circuit. However, if the regulated output is low (below 250 volts) it will be necessary to provide additional negative voltage for the reference tube circuit. Also, if the regulated output voltage is to be variable, it may be necessary to follow Figure 1.

Passing tube operation conditions should be chosen to provide as low a tube drop as possible. A safety margin of at least 5 volts from the zero bias line should be allowed however, for variations of individual tubes. Sufficient bias excursion should be allowed for overcoming ripple. The amplifier circuit should be able to counteract the effect of unbalance due to tube ageing.

A grid resistor should be used for each triode section. This should be enough to prevent parasitic oscillation but not large enough to prevent loss of control due to a small amount of "gas" grid current. A value of grid resistance that meets both these conditions is 1,000 ohms. Heater voltage should be kept as close as possible to 6.3 volts as measured on the tube pins. When connecting many high drain tube heaters across a single transformer, bus bars feeding from "alternate ends" (Figure 3) should be used with a stranded pair feeding individual sockets.

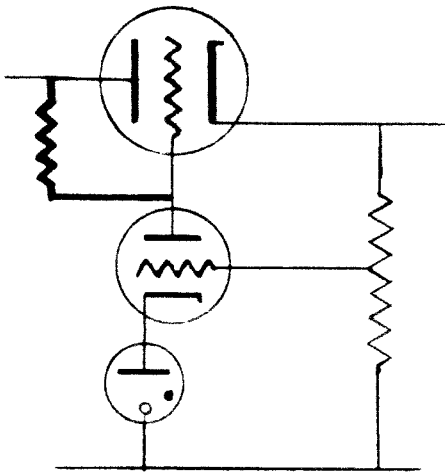

FIGURE 1

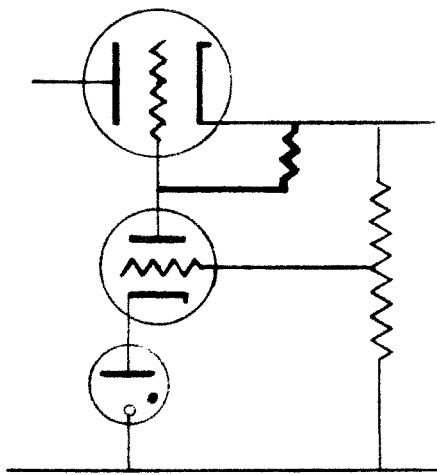

FIGURE 2

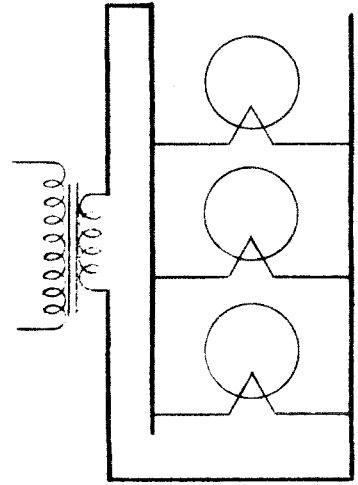
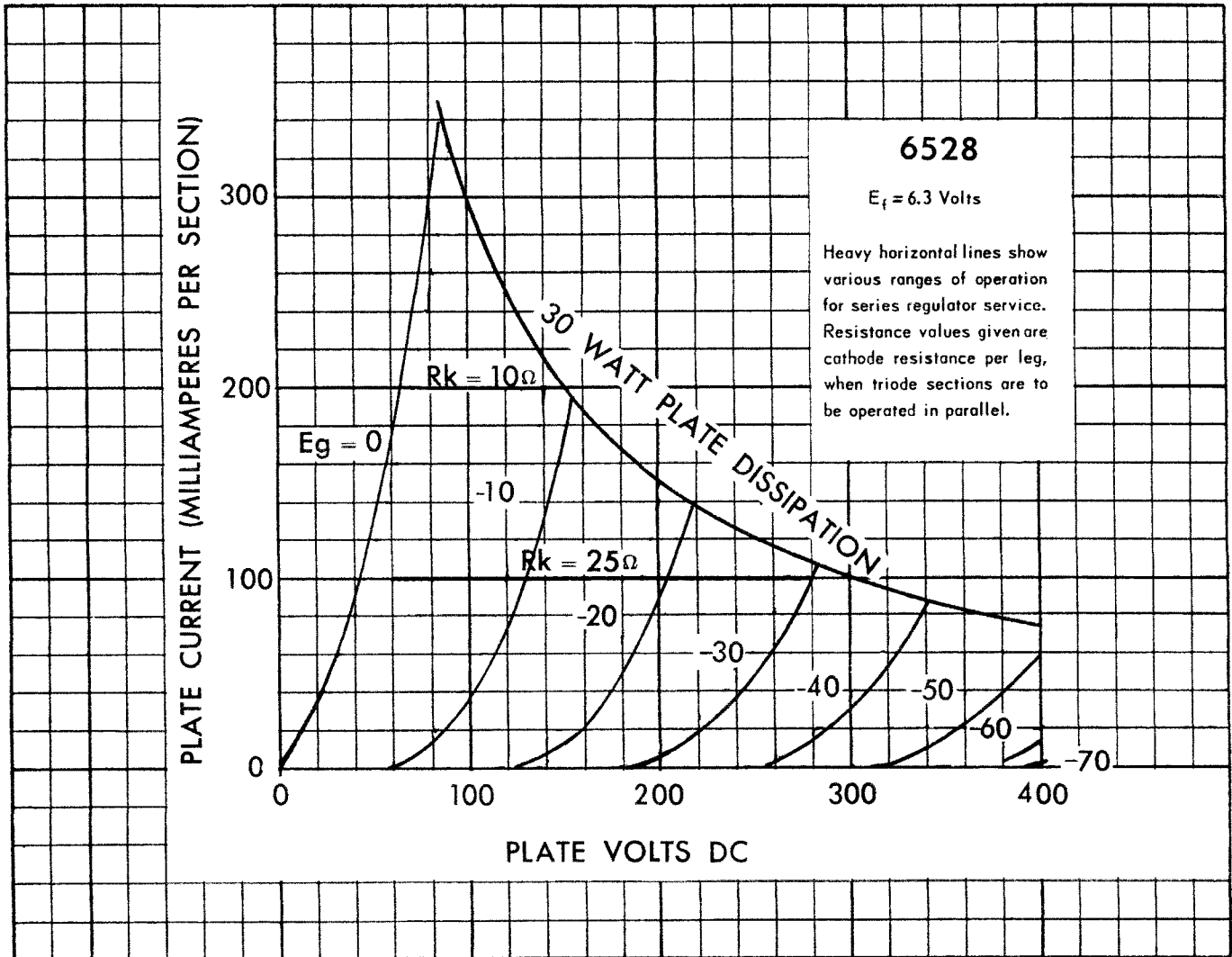

FIGURE 3

AVERAGE PLATE CHARACTERISTICS FOR EACH TRIODE UNIT



6528 TUNG-SOL / CHATHAM

TRANSFER CHARACTERISTICS FOR EACH TRIODE SECTION

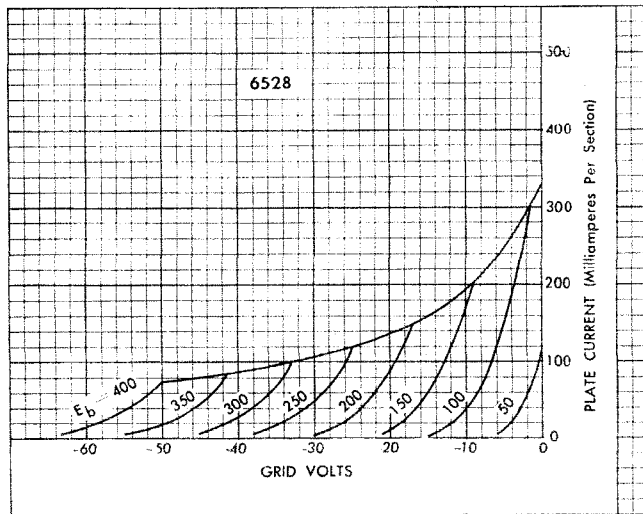

AVERAGE CHARACTERISTICS

